

LDA600

Light Weight Portable Diesel Pump

- Light weight
- Portable
- Robust cast pump casing



The Angus LDA600 pump is a light weight portable fire or industrial pump that combines the benefits of high pressure fire fighting performance with an extremely compact design.

The unit is designed to be carried by two people and operated by one. Electric start (and a simple hand start with decompression facility) plus exhaust ejector priming mean the pump can be put into service quickly and easily in an emergency situation.

Typical flows range from 600* l/min at 7 bar delivery to over 1,400* l/min at 2 bar.

The LDA600 uses the internationally renowned Kohler 2 cylinder air cooled diesel engine for reliability.

Angus fire pumps use robust cast pump casings which allow the use of substantial input pressures from hydrants or relay pumps without damaging the pump; a feature generally not available with lower specification pumps.

Applications

Municipal Fire Brigades

600 l/min* at 7 bar provides a fire service with two hand lines for direct fire fighting.

Flood Relief

In situations where flow rather than pressure is critical the LDA600 will provide up to 1,500 l/min*

Standard Features

- 4 litre fuel tank capacity (1½ hours at maximum speed)
- Fast and simple exhaust eject priming – 3m in under 20 seconds
- Grade 304 stainless steel frame and fabricated components

- Grade 6061 light alloy corrosion resistant pump body and impeller heat treated to T6.
- Glycerine filled compound and output pressure gauge
- Wheel set for one man portability

Engine

Kohler 25LD25 851cc direct injection diesel engine 14.1 kW (19 hp) at 3,600 rpm. 42 Nm (30 ft lbs) at 2,200 rpm. Two cylinder in line, pressure lubricated.

Speed Control

Factory set internal mechanical governor

Cooling

Forced ventilation, ducted path crankshaft driven fan

Electrical

12v negative earth system with 16 amp engine driven alternator

Angle of Operation

15° from horizontal in any plane

Exhaust

Steel silencer arranged to direct exhaust gas away from the operators position

Starting

Electric start standard
Hand pull emergency start facility with manual decompression

Ambient Temperature Range

Full power continuous operation -30°C† (-22°F†) to +38°C (100°F)

Security

Fixed key start – pull stop facility

Emissions

Diesel engines below 19 kW for non-road applications are exempt from EEC emission regulations

CE Marking

The LDA600 portable pump is CE marked for sale and use within the EEC

Sound Level

97 dB at 3 bar outlet pressure††

Frame

Corrosion resistant 304 grade stainless steel outer frame and fabricated components
4 x Stainless steel fold away carrying handles with rubber grips lockable into position
Wheel set for one man portability

Pump

Corrosion resistant light alloy body and impeller cast from 6061 grade aluminium heat treated to level T6. Maintenance free, spring loaded, carbon-faced/ceramic shaft seal. Drain point.

Pump Pressure Rating

Pump housing designed to withstand 1½ maximum working pressure and to accept input pressures from hydrants or relay pumps.

Pump Clearances

Centrifugal pumps will allow small solids to pass through the impeller and pump without causing damage. All Angus pumps are fitted with an inlet mesh filter which is smaller than the minimum clearance size of the impeller.
Inlet filter screen size 9 mm
Impeller clearance 12 mm

Priming

Manually actuated exhaust ejector system
3m lift (9" Hg) in under 20 seconds

Fuel tank

4 litre (0.9 imperial gallon)
Industrial plastic tank with top filling cap and inspection point



ANGUS FIRE

LDA600

Light Weight Portable Diesel Pump

Inlet

Standard 100mm (4") British Standard Round thread - male connection

Outlet

Twin screw down bronze valves
Standard 2½" BS336 instantaneous female couplings (other options available)

Instrumentation

Inlet glycerine filled compound gauge, 64mm Ø, scale -1 to +9 bar
Outlet glycerine filled pressure gauge, 64mm Ø, scale 0 to 25 bar
Engine hour run meter
Oil pressure indicator
Battery charge indicator

Options

Marine grade bronze (BS EN 1982 / LG2 gunmetal) pump body and impeller.
Alternative inlet/outlet, storz, US fire thread, BSP
Tripod light
Inlet/outlet plugs and chains
Suction and discharge hoses, suction strainers and accessories

Angus Fire is assessed by BSI and operates ISO 9001 Quality Management Systems and ISO 14001 Environmental Management Systems.

† Special oil may be required.

†† Readings taken at position 1m horizontally from the controls and 1.7m vertically to represent the typical position of the operators head.

Dimensions

Length	760 mm (23½")
Width	530 mm (21")
Height	580 mm (24½")
Weight	115 Kg with battery, fuel and oil (dry weight 106 Kg - incl. battery)

Performance

Outlet Pressure*	Flow**
Free flow	1,500 l/min
1 bar	1,470 l/min
2 bar	1,400 l/min
3 bar	1,300 l/min
4 bar	1,150 l/min
5 bar	950 l/min
6 bar	780 l/min
7 bar	600 l/min
8 bar	350 l/min

* Based on 3m suction lift.

** All flow data is subject to a +/- 5% manufacturing and testing tolerance.

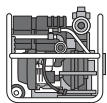
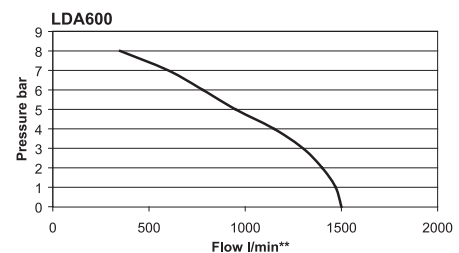
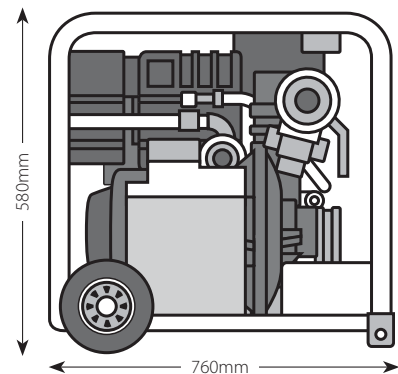

LDA 400

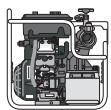

LWA 500

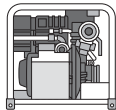

LDA 600

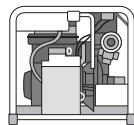

LWA 800

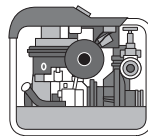

LWA 1200

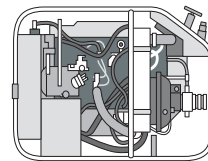

LD 1800

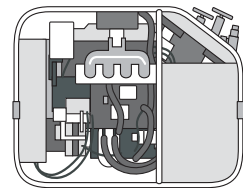

LW 2250

INTERNATIONAL SALES

Angus Fire Ltd

Angus House, Haddenham Business Park,
Pegasus Way, Haddenham, Aylesbury, HP17 8LB, UK
Tel: +44 (0)1844 293600 • Fax: +44 (0)1844 293664

UK SALES

Angus Fire Ltd

Station Road, Bentham, Lancaster, LA2 7NA, UK
Tel: +44 (0)1524 264000 • Fax: +44 (0)1524 264180

Angus Fire operates a continuous programme of product development. The right is therefore reserved to modify any specification without prior notice and Angus Fire should be contacted to ensure that the current issues of all technical data sheets are used.